



**VERTIV™**  
维谛技术

Vertiv™

E系列蓄电池

12V33~200Ah

阀控式铅酸胶体蓄电池



## E 系列（高性能工业型）胶体蓄电池简介

E 系列 12V 阀控式铅酸胶体蓄电池，正负极板栅采用耐蚀铅钙锡多元合金，电解质材料采用气相二氧化硅制作的胶体电解液，其富液量设计、气体再化合设计、极板固化工艺、化成工艺保证了蓄电池具有优异的抗深放电性能、欠充电循环性能和更好的安全性与可靠性，非常适合工业现场应用的要求。

## 产品技术特点

### 长寿命

正负极板栅采用耐蚀铅钙锡多元合金，气体再化合技术；电解质材料采用气相二氧化硅制作，胶体电解液降低了对板栅的腐蚀；极板固化工艺、化成工艺保证了电池的 15 年浮充设计寿命。

### 更宽的工作温度区间

电池内部采用过量电解质设计，可在环境温度为 -20℃~55℃的工作场所使用；即使在高温及过充情况下仍能可靠工作，电池不会“干涸”。

### 优异的抗深放电性能

电池深放电后再充电的恢复能力强，100%放电后仍可继续接在负载上，放置 4 周时间再充电，仍可恢复原容量。

### 优异的欠充电循环性能

电池内部采用过量电解质设计，凝胶电解质在长期欠充电状态下，电池也不会“干涸”，不会因为欠充电而损坏，有很好的欠充电循环能力。

### 更好的安全性与可靠性

凝胶电解质采用气相二氧化硅配制，电解质在成品电池中呈现凝胶状态、不流动，无漏液及分层现象；电池采用准富液量设计，在高温及过充电的情况下，不易出现干涸现象，不会产生热失控现象。

### 适合工业现场应用

电池整体循环寿命高（50% 深度放电循环 1600 次）、耐过放电、可以长期不充电又进行放电，非常适合工业现场应用。

类型	标称电压	容量
阀控密封铅酸电池	12V	330~200Ah
技术	执行标准	设计寿命
胶体免维护	IEC60896-21/22 DIN43539-T5	15年

## 应用

- 电力、石化行业备用电源
- 铁路、机场等各种应急系统备用电源
- 太阳能、风能、光伏发电储能
- 船舶、海事系统等备用电源



## 产品型号与尺寸

型号 / 参数	标称电压 (V)	C10(Ah) @25°C	30min 恒功率 (wpc/1.75V)	外形尺寸 (mm)				重量 (kg)	极柱 (mm)	扭矩 (N.m)
				长 (L)	宽 (W)	高 (H)	总高 (TH)			
U12V33E/A	12	33	56.5	198	166	162	170	14	M6	8-10
U12V50E/A	12	50	85.6	276	174	169	198	21	M8	12-16
U12V65E/A	12	65	111	310	174	209	236	27	M8	12-16
U12V85E/A	12	85	146	414	174	218	228	34	M8	12-16
U12V100E/A	12	100	171	513	163	218	228	40	M8	12-16
U12V120E/A	12	120	205	513	232	218	228	47	M8	12-16
U12V150E/A	12	150	257	513	232	218	228	59	M8	12-16
U12V200E/A	12	200	342	513	296.5	218	228	75.5	M8	12-16

## 电池外形图

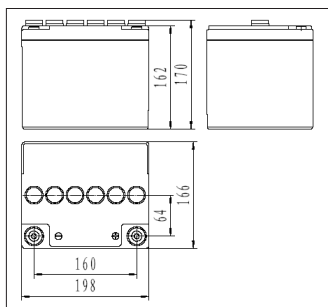

U12V33E/A

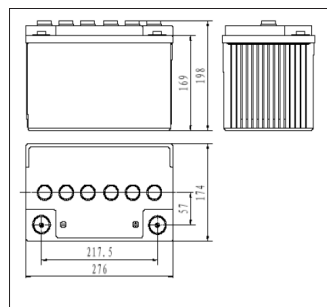

U12V50E/A

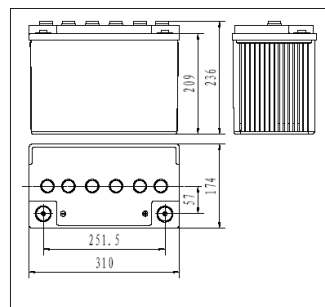

U12V65E/A

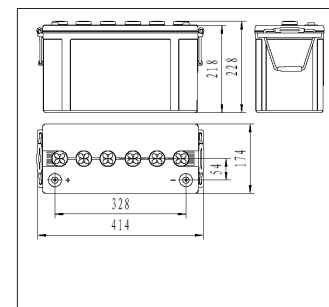

U12V85E/A

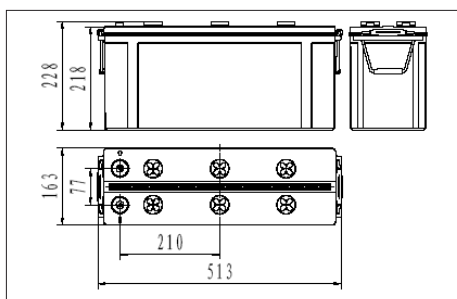

U12V100E/A

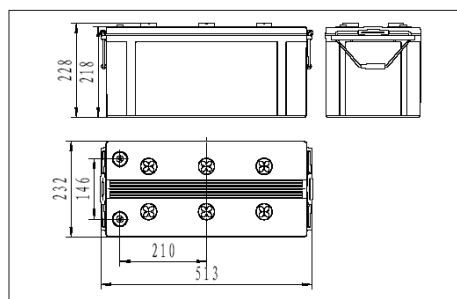

U12V120E/A-U12V150E/A

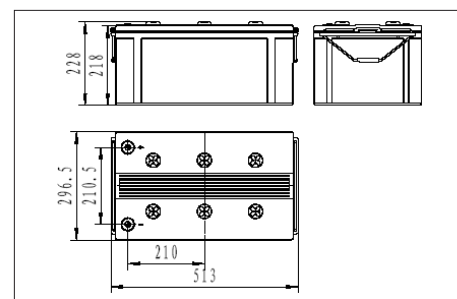

U12V200E/A

## 性能曲线

不同放电深度下的循环曲线

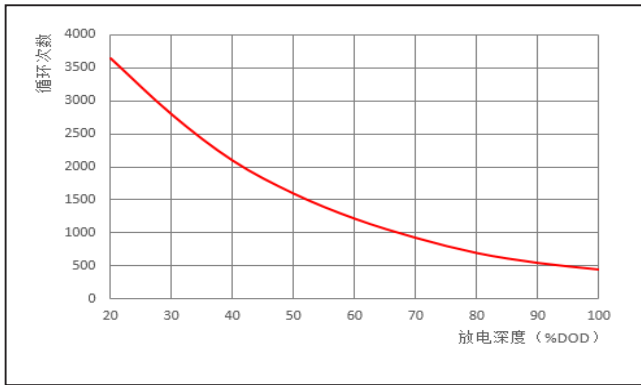

不同放电深度下的充电曲线

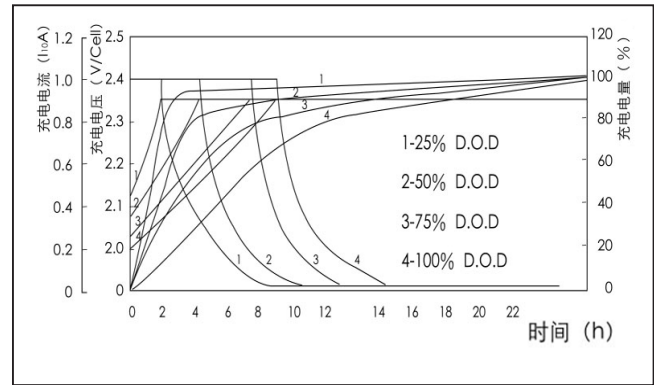

不同温度下的放电容量曲线

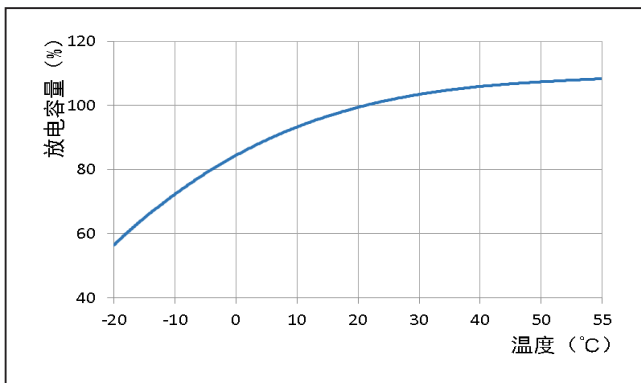

不同温度下浮充寿命曲线

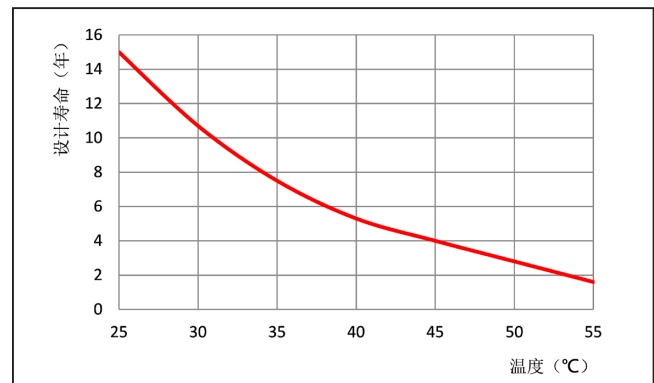

## 恒电流放电数据表

### 1.60V/C-Discharge in A at 25°C

型号 / 放电时间	15min	30min	45min	1h	1.5h	2h	3h	4h	5h	6h	8h	10h	20h	24h	48h	100h	120h	240h
U12V33E/A	51.5	33	23	19.5	14.8	11.6	9	7.2	6.1	5.6	4.3	3.6	1.86	1.57	0.78	0.38	0.36	0.19
U12V50E/A	78	50	34.9	29.5	22.5	17.5	13.7	11	9.3	8.5	6.6	5.5	2.82	2.38	1.19	0.57	0.55	0.29
U12V65E/A	101.4	65	45.3	38.3	29.2	22.8	17.8	14.2	12.1	11	8.5	7.1	3.67	3.9	1.54	0.74	0.71	0.37
U12V85E/A	133	85	59.3	50.1	38.2	29.8	23.3	18.6	15.8	14.4	11.2	9.3	4.79	4.5	2.2	0.97	0.93	0.49
U12V100E/A	156	100	69.8	59	44.9	35.1	27.4	21.9	18.6	17	13.1	11	5.64	4.76	2.37	1.14	1.9	0.57
U12V120E/A	187	120	83.7	70.8	53.9	42.1	32.8	26.3	22.3	20.4	15.8	13.1	6.77	5.71	2.84	1.37	1.31	0.68
U12V150E/A	234	150	105	88.4	67.4	52.6	41	32.9	27.9	25.4	19.7	16.4	8.46	7.14	3.56	1.71	1.64	0.86
U12V200E/A	312	200	140	118	89.8	70.1	54.7	43.8	37.2	33.9	26.3	21.9	11.3	9.52	4.74	2.28	2.18	1.14

### 1.65V/C-Discharge in A at 25°C

型号 / 放电时间	15min	30min	45min	1h	1.5h	2h	3h	4h	5h	6h	8h	10h	20h	24h	48h	100h	120h	240h
U12V33E/A	49.9	32.3	22.6	19.1	14.5	11.3	8.9	7.1	6	5.5	4.3	3.5	1.82	1.54	0.77	0.37	0.36	0.19
U12V50E/A	75.7	49	34.2	28.9	22	17.2	13.4	10.7	9.1	8.3	6.4	5.4	2.76	2.34	1.16	0.57	0.54	0.28
U12V65E/A	98.4	63.7	44.4	37.6	28.6	22.3	17.4	14	11.9	10.8	8.4	7	3.59	3.4	1.51	0.74	0.7	0.36
U12V85E/A	129	83.3	58.1	49.1	37.4	29.2	22.8	18.2	15.5	14.1	11	9.1	4.69	3.97	1.97	0.96	0.92	0.48
U12V100E/A	151	98	68.4	57.8	44	34.4	26.8	21.5	18.2	16.6	12.9	10.7	5.52	4.67	2.32	1.13	1.8	0.57
U12V120E/A	182	118	82	69.3	52.8	41.2	32.2	25.8	21.9	20	15.5	12.9	6.62	5.6	2.78	1.36	1.3	0.67
U12V150E/A	227	147	103	86.7	66	51.5	40.2	32.2	27.4	24.9	19.3	16.1	8.28	7.1	3.48	1.7	1.62	0.84
U12V200E/A	303	196	137	116	88	68.7	53.6	42.9	36.5	33.3	25.8	21.5	11.0	9.34	4.64	2.26	2.16	1.12

### 1.70V/C-Discharge in A at 25°C

型号 / 放电时间	15min	30min	45min	1h	1.5h	2h	3h	4h	5h	6h	8h	10h	20h	24h	48h	100h	120h	240h
U12V33E/A	48.4	31.7	22.1	18.7	14.2	11.1	8.7	6.9	5.9	5.4	4.2	3.5	1.79	1.51	0.76	0.37	0.35	0.18
U12V50E/A	73.4	48	33.5	28.3	21.6	16.9	13.1	10.5	8.9	8.2	6.3	5.3	2.71	2.29	1.15	0.56	0.54	0.28
U12V65E/A	95.4	62.4	43.6	36.8	28	21.9	17.1	13.7	11.6	10.6	8.2	6.8	3.52	2.98	1.49	0.73	0.7	0.36
U12V85E/A	125	81.6	57	48.1	36.7	28.7	22.3	17.9	15.2	13.9	10.7	8.9	4.6	3.89	1.95	0.95	0.91	0.47
U12V100E/A	147	96	67	56.6	43.1	33.7	26.3	21	17.9	16.3	12.6	10.5	5.41	4.58	2.29	1.12	1.7	0.55
U12V120E/A	176	115	80.4	68	51.8	40.4	31.5	25.2	21.5	19.6	15.1	12.6	6.49	5.5	2.75	1.34	1.28	0.66
U12V150E/A	220	144	101	84.9	64.7	50.6	39.4	31.5	26.8	24.5	18.9	15.8	8.12	6.87	3.44	1.68	1.61	0.83
U12V200E/A	293	192	134	113	86.3	67.4	52.5	42.1	35.8	32.6	25.2	21	10.8	9.16	4.58	2.24	2.14	1.1

# Vertiv™ E 系列蓄电池 12V33~200Ah 阀控式铅酸胶体蓄电池

## 1.75V/C-Discharge in A at 25°C

型号 / 放电时间	15min	30min	45min	1h	1.5h	2h	3h	4h	5h	6h	8h	10h	20h	24h	48h	100h	120h	240h
U12V33E/A	47	31.1	21.6	18.3	14	10.9	8.5	6.8	5.8	5.3	4.1	3.4	1.75	1.48	0.74	0.37	0.35	0.18
U12V50E/A	71.2	47	32.8	27.8	21.1	16.5	12.9	10.3	8.8	8	6.2	5.2	2.66	2.25	1.13	0.56	0.53	0.27
U12V65E/A	92.6	61.2	42.6	36.1	27.5	21.5	16.7	13.4	11.4	10.4	8	6.7	3.45	2.92	1.46	0.72	0.69	0.35
U12V85E/A	121	80	55.7	47.2	35.9	28.1	21.9	17.5	14.9	13.6	10.5	8.8	4.51	3.82	1.91	0.94	0.9	0.46
U12V100E/A	142	94.1	65.6	55.5	42.3	33	25.7	20.6	17.5	16	12.4	10.3	5.31	4.49	2.25	1.11	16	0.54
U12V120E/A	171	113	78.7	66.6	50.7	39.6	30.9	24.7	21	19.2	14.8	12.4	6.37	5.39	2.7	1.33	1.27	0.65
U12V150E/A	214	141	98.3	83.3	63.4	49.5	38.6	30.9	26.3	24	18.6	15.5	7.97	6.74	3.38	1.67	1.59	0.81
U12V200E/A	285	188	131	111	84.5	66	51.4	41.2	35	31.9	24.7	20.6	10.6	8.98	4.5	2.22	2.12	1.08

## 1.80V/C-Discharge in A at 25°C

型号 / 放电时间	15min	30min	45min	1h	1.5h	2h	3h	4h	5h	6h	8h	10h	20h	24h	48h	100h	120h	240h
U12V33E/A	44.7	30.1	21	17.8	13.5	10.6	8.3	6.6	5.6	5.1	4	3.3	1.72	1.45	0.73	0.36	0.35	0.18
U12V50E/A	67.7	45.6	31.9	26.9	20.5	16	12.5	10	8.5	7.8	6	5	2.6	2.2	1.11	0.55	0.53	0.27
U12V65E/A	88	59.3	41.4	35	26.7	20.8	16.3	13	11.1	10.1	7.8	6.5	3.38	2.86	1.44	0.72	0.68	0.35
U12V85E/A	115	77.6	54.1	45.8	34.9	27.2	21.3	17	14.5	13.2	10.2	8.5	4.42	3.74	1.89	0.94	0.89	0.45
U12V100E/A	135	91.3	63.7	53.8	41	32	25	20	17	15.5	12	10	5.2	4.4	2.22	1.1	15	0.53
U12V120E/A	162	110	76.4	64.6	49.2	38.4	30	24	20.4	18.6	14.4	12	6.24	5.28	2.66	1.32	1.26	0.64
U12V150E/A	203	137	95.5	80.7	61.5	48	37.5	30	25.5	23.3	18	15	7.8	6.6	3.33	1.65	1.58	0.8
U12V200E/A	271	183	127	108	82	64	50	40	34	31	24	20	10.4	8.8	4.44	2.2	2.1	1.06

## 恒功率放电数据表

### 1.60V/C-Discharge in W/cell at 25°C

型号 / 放电时间	15min	30min	45min	1h	1.5h	2h	3h	4h	5h	6h	8h	10h	20h	24h	48h	100h	120h	240h
U12V33E/A	89.6	57.7	40.3	34.2	26.1	20.4	16.2	13.2	11.2	10.2	8	6.7	3.57	35	1.53	0.75	0.72	0.38
U12V50E/A	136	87.5	61	51.9	39.5	30.9	24.5	19.9	17	15.4	12.1	10.2	5.41	4.62	2.32	1.13	19	0.58
U12V65E/A	176	114	79.4	67.5	51.4	40.1	31.8	25.9	22.2	20.1	15.7	13.2	7.4	60	32	1.48	1.42	0.75
U12V85E/A	231	149	104	88.2	67.2	52.5	41.6	33.9	29	26.2	20.6	17.3	9.2	7.85	3.95	1.93	1.85	0.98
U12V100E/A	271	175	122	104	79	61.7	49	39.9	34.1	30.9	24.2	20.4	10.8	9.23	4.65	2.27	2.18	1.15
U12V120E/A	326	210	146	125	94.8	74	58.8	47.8	40.9	37	29	24.4	13	11.1	5.57	2.72	2.62	1.38
U12V150E/A	407	262	183	156	119	92.6	73.5	59.8	51.1	46.3	36.3	30.6	16.2	13.9	6.97	3.4	3.27	1.73
U12V200E/A	543	350	244	208	158	123	97.9	79.7	68.1	61.7	48.4	40.7	21.7	18.5	9.29	4.54	4.36	2.3

### 1.65V/C-Discharge in W/cell at 25°C

型号 / 放电时间	15min	30min	45min	1h	1.5h	2h	3h	4h	5h	6h	8h	10h	20h	24h	48h	100h	120h	240h
U12V33E/A	87.9	57.2	39.9	33.9	26	20.3	16.1	13	11.1	10.2	7.9	6.7	3.53	32	1.52	0.75	0.72	0.38
U12V50E/A	133	86.7	60.5	51.4	39.4	30.8	24.4	19.7	16.9	15.4	12	10.1	5.35	4.58	2.3	1.13	19	0.57
U12V65E/A	173	113	78.7	66.9	51.2	40	31.7	25.7	21.9	20	15.6	13.2	6.96	5.95	2.99	1.47	1.41	0.74
U12V85E/A	226	147	103	87.4	67	52.3	41.5	33.6	28.7	26.2	20.4	17.2	9.1	7.78	3.91	1.92	1.85	0.97
U12V100E/A	266	173	121	103	78.8	61.5	48.8	39.5	33.7	30.8	24	20.3	10.7	9.15	4.59	2.26	2.17	1.14
U12V120E/A	320	208	145	123	94.5	73.8	58.6	47.4	40.5	36.9	28.7	24.3	12.9	11	5.51	2.71	2.6	1.36
U12V150E/A	399	260	181	154	118	92.3	73.2	59.2	50.6	46.1	35.9	30.4	16.1	13.7	6.89	3.39	3.26	1.71
U12V200E/A	533	347	242	206	158	123	97.6	79	67.5	61.5	47.9	40.6	21.4	18.3	9.19	4.52	4.34	2.27

### 1.70V/C-Discharge in W/cell at 25°C

型号 / 放电时间	15min	30min	45min	1h	1.5h	2h	3h	4h	5h	6h	8h	10h	20h	24h	48h	100h	120h	240h
U12V33E/A	86.2	56.7	39.6	33.6	25.8	20.2	15.9	12.8	11	10.1	7.9	6.7	3.5	30.1	1.5	0.74	0.71	0.37
U12V50E/A	131	85.9	60	51	39	30.7	24.2	19.5	16.7	15.3	11.9	10.1	5.3	4.56	2.28	1.13	18	0.56
U12V65E/A	170	112	78	66.3	50.7	39.9	31.4	25.3	21.7	19.9	15.5	13.1	6.89	5.92	2.96	1.46	1.41	0.73
U12V85E/A	222	146	102	86.6	66.4	52.1	41.1	33.1	28.4	26.1	20.3	17.2	9.1	7.75	3.87	1.91	1.84	0.95
U12V100E/A	261	172	120	102	78.1	61.3	48.3	38.9	33.4	30.6	23.9	20.2	10.6	9.11	4.56	2.25	2.16	1.12
U12V120E/A	313	206	144	122	93.7	73.6	58	46.7	40.1	36.8	28.6	24.2	12.7	10.9	5.47	2.7	2.59	1.35
U12V150E/A	392	258	180	153	117	92	72.5	58.4	50.2	46	35.8	30.3	15.9	13.7	6.84	3.38	3.24	1.68
U12V200E/A	522	344	240	204	156	123	96.6	77.8	66.9	61.3	47.7	40.4	21.2	18.2	9.11	4.50	4.32	2.24

### 1.75V/C-Discharge in W/cell at 25°C

型号 / 放电时间	15min	30min	45min	1h	1.5h	2h	3h	4h	5h	6h	8h	10h	20h	24h	48h	100h	120h	240h
U12V33E/A	85.1	56.5	39.4	33.3	25.7	20.2	15.8	12.7	10.9	10.1	7.8	6.6	3.45	2.96	1.49	0.74	0.71	0.37
U12V50E/A	129	85.6	59.7	50.5	38.9	30.5	23.9	19.3	16.5	15.3	11.9	10	5.23	4.49	2.25	1.12	18	0.55
U12V65E/A	168	111	77.6	65.7	50.5	39.7	31.1	25.1	21.5	19.8	15.4	13.1	6.8	5.84	2.93	1.46	1.4	0.72
U12V85E/A	219	146	101	85.9	66.1	51.9	40.7	32.8	28.1	25.9	20.2	17.1	8.89	7.63	3.83	1.91	1.83	0.94
U12V100E/A	258	171	119	101	77.8	61.1	47.8	38.6	33.1	30.5	23.8	20.1	10.5	8.98	4.5	2.24	2.15	1.11
U12V120E/A	309	205	143	121	93.3	73.3	57.4	46.3	39.7	36.6	28.5	24.1	12.6	10.8	5.4	2.69	2.58	1.33
U12V150E/A	387	257	179	152	117	91.6	71.8	57.8	49.6	45.8	35.6	30.1	15.7	13.5	6.75	3.36	3.23	1.66
U12V200E/A	515	342	239	202	156	122	95.7	77.1	66.2	61	47.5	40.2	20.9	18	9	4.48	4.3	2.21

### 1.80V/C-Discharge in W/cell at 25°C

型号 / 放电时间	15min	30min	45min	1h	1.5h	2h	3h	4h	5h	6h	8h	10h	20h	24h	48h	100h	120h	240h
U12V33E/A	83.1	55.7	38.9	33	25.4	20.1	15.7	12.6	10.8	10	7.8	6.5	3.43	2.92	1.47	0.74	0.71	0.36
U12V50E/A	126	84.4	58.9	50.1	38.5	30.4	23.8	19.1	16.4	15.1	11.8	9.9	5.2	4.42	2.23	1.12	1.07	0.55
U12V65E/A	164	110	76.6	65.1	50.1	39.5	30.9	24.8	21.3	19.7	15.3	12.9	6.76	5.75	2.9	1.45	1.39	0.71
U12V85E/A	214	143	100	85.1	65.5	51.7	40.4	32.5	27.9	25.7	20	16.8	8.84	7.52	3.79	1.9	1.82	0.93
U12V100E/A	252	169	118	100	77.1	60.8	47.5	38.2	32.8	30.2	23.5	19.8	10.4	8.84	4.46	2.23	2.14	1.09
U12V120E/A	302	203	141	120	92.5	73	57	45.8	39.4	36.3	28.2	23.8	12.5	10.6	5.35	2.68	2.57	1.31
U12V150E/A	377	253	177	150	116	91.2	71.3	57.3	49.2	45.3	35.3	29.7	15.6	13.3	6.69	3.35	3.21	1.64
U12V200E/A	503	338	236	200	154	122	95	76.4	65.6	60.5	47	39.6	20.8	17.7	8.92	4.47	4.28	2.18